

sidekiq™ X4

High Bandwidth, Multi-Channel
RF Transceiver in a VITA
57.1 (FMC) form factor for
Advanced Solutions

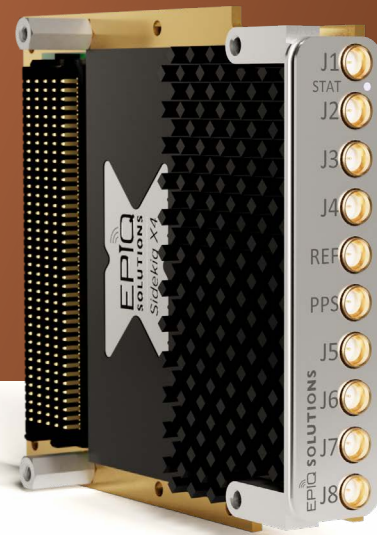

approx. actual size

Maximize Your RF

800 MHz Instantaneous BW and 3U VPX Compatible

The Sidekiq X4 multi-channel RF transceiver card introduces a new level of RF integration and capability, reducing product development times and improving wideband range, versatility, and performance. Integrating two Analog Devices' ADRV9009 wideband transceivers, Sidekiq X4 creates a very flexible, high capacity RF transceiver solution that resides in VITA 57.1 FPGA Mezzanine Card (FMC) compliant form factor. These features, along with multi-band pre-select filtering on each of the four receive paths, facilitate the development of complex RF solutions and applications such as:

- Satellite Communications
- Digital Radio Frequency Memory (DRFM)
- EW/EA Systems
- Wideband RF Record and Playback
- Spectrum Monitoring
- 5G Cellular Systems
- 802.11 AC/AX Systems
- Direction Finding



Sidekiq X4 housed in a
Thunderbolt 3 chassis

KEY FEATURES

- Configurable RF channel bandwidth up to 200 MHz per channel, for support of up to **800 MHz instantaneous bandwidth (IBW)**
- **3U VPX** and PCIe3/Thunderbolt™ 3 deployment options available with COTS carriers
- Operates in **four-channel phase coherent mode** for 200 MHz IBW per channel **or in a dual-independently tunable mode** supporting 400 MHz IBW per channel
- **Four RF transmitters** (phase coherent or two phase coherent pairs)
- Continuous RF range between **1 MHz and 6 GHz**
- Exceptional dynamic range with **16-bit A/D** and **14-bit D/A** converters
- VITA 57.1 FPGA Mezzanine Card (**FMC**) with high pin count (HPC) interface

RF RECEIVER SPECIFICATIONS

Number of Receivers

Four channels as: phase coherent, two phase coherent pairs or dual high bandwidth

RF Tuning Range

1 MHz to 6 GHz

RF Tuning Step Size

< 5 Hz

RF Channel Bandwidth

Up to 200 MHz (configurable to 400 MHz in dual high bandwidth mode)

Typical Rx Noise Figure

8 dB

Typical Input IP3 (at 8 dB noise figure)

+8 dBm

Max A/D Converter Sample Rate

245.76 Msamples/sec

A/D Converter Sample Width

16 bits

Rx Gain Modes

Manual or automatic (AGC)

Pre-Select Filter

Seven bandpass RF filters on each RF receiver

RF TRANSMITTER SPECIFICATIONS

Number of Phase Coherent Transmitters

Four channels as: phase coherent or two phase coherent pairs

RF Tuning Range

1 MHz to 6 GHz

RF Channel Bandwidth

Up to 200 MHz

Typical RF Output Power

Up to +5 dBm

Max D/A Sample Rate

245.76 Msamples/sec

D/A Converter Sample Width

14 bits

RF Tuning Step Size

< 5 Hz

BLOCK DIAGRAM

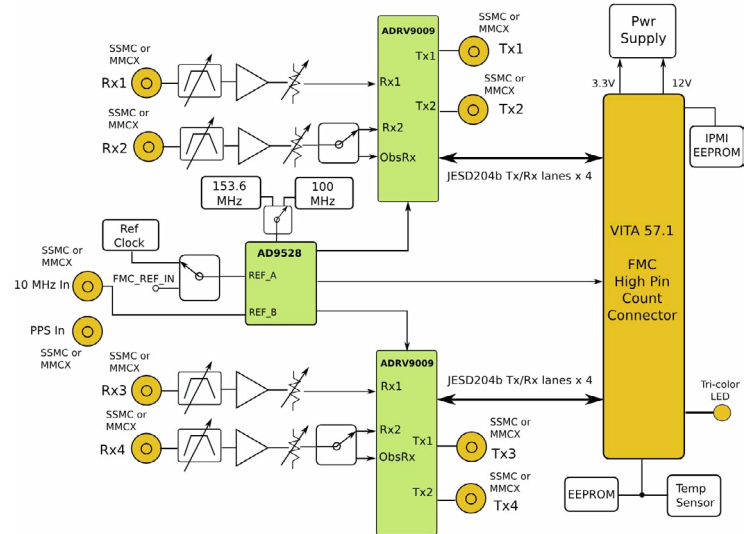

DIGITAL SPECIFICATIONS

A/D and D/A interface to Host System

JESD204b

Additional I/O from Host

I2C + singled-ended GPIO

PPS Input

Direct to host system FPGA (for timestamping)

10 MHz Reference Input

For phase locking card to external system

MECHANICAL SPECIFICATIONS

Form Factor

VITA 57.1 High Pin Count FPGA Mezzanine Card (FMC)

Thermal Management

Convection cooled (conduction option on request)

Typical Power Consumption

7 - 14 Watts (depending on # of channels in use)

Component Temperature Rating

-40 to +85 degrees C

RF Connector Options

MMCX, SSMC and SMP

All specifications are subject to change without notice.

Epiq Solutions is a small business dedicated to advancing RF technology through products designed and manufactured in the U.S.A.



Sideiq X4 in a 3U VPX carrier card

For more information about Sideiq X4 and the available Development Kit options, please contact Epiq Solutions.

Epiq Solutions exports its products strictly in accordance with all US Export Control laws and regulations which shall apply to any purchase or order.



web: epiqsolutions.com
 email: sales@epiqsolutions.com
 phone: (847) 598-0218

3740 Industrial Avenue
 Rolling Meadows, IL
 60008